

KT

Grommets, small, single

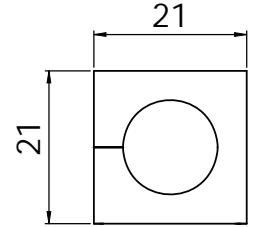

1

Description	Type	Order No gray	Order No black	Clamping range	PU
-------------	------	------------------	-------------------	----------------	----

Product Description

Cable grommets KT small are used with the following cable entry frames:

KEL-U/KEL-ER/KEL (8 - 34) | KVT (38 - 42)

The model range KT small is designed for cable diameters from 2 to 17 mm.

Assembly Note







When installing the grommets, the flat side should be facing the middle of the frame. This allows the flat sides of adjacent grommets to match up and provide a secure seal.

Specifications KT gray

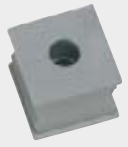
Material	Elastomer
Flame class	UL94-Vo
IP rating	KT round, single: up to IP65 (in combination with KEL-ER frame) KT special/blank: IP54
NEMA type rating	up to NEMA type 4X (acc. to UL 50E)
Temperature	- 30°C to + 90°C (static) - 40°F to + 194°F (static)
Properties	Halogen-free, silicone-free

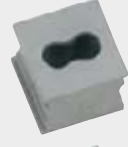
Specifications KT black

Material	Elastomer
Flame class	UL94-HB
IP rating	KT round, single: up to IP65 (in combination with KEL-ER frame) KT special/blank: IP54
NEMA type rating	up to NEMA type 4X (acc. to UL 50E)
Temperature	- 30°C to + 90°C (static) - 40°F to + 194°F (static)
Properties	Higher chemical resistance

BTK		BTK	<input type="checkbox"/> 41251	<input checked="" type="checkbox"/> 41351	Blank grommet	10
KT round		KT 2	<input type="checkbox"/> 39934	<input checked="" type="checkbox"/> 41302	2 - 3 mm	10
		KT 3	<input type="checkbox"/> 41203	<input checked="" type="checkbox"/> 41303	3 - 4 mm	10
		KT 4	<input type="checkbox"/> 41204	<input checked="" type="checkbox"/> 41304	4 - 5 mm	10
		KT 5	<input type="checkbox"/> 41205	<input checked="" type="checkbox"/> 41305	5 - 6 mm	10
		KT 6	<input type="checkbox"/> 41206	<input checked="" type="checkbox"/> 41306	6 - 7 mm	10
		KT 7	<input type="checkbox"/> 41207	<input checked="" type="checkbox"/> 41307	7 - 8 mm	10
		KT 8	<input type="checkbox"/> 41208	<input checked="" type="checkbox"/> 41308	8 - 9 mm	10
		KT 9	<input type="checkbox"/> 41209	<input checked="" type="checkbox"/> 41309	9 - 10 mm	10
		KT 10	<input type="checkbox"/> 41210	<input checked="" type="checkbox"/> 41310	10 - 11 mm	10
		KT 11	<input type="checkbox"/> 41211	<input checked="" type="checkbox"/> 41311	11 - 12 mm	10
		KT 12	<input type="checkbox"/> 41212	<input checked="" type="checkbox"/> 41312	12 - 13 mm	10
		KT 13	<input type="checkbox"/> 41213	<input checked="" type="checkbox"/> 41313	13 - 14 mm	10
		KT 14	<input type="checkbox"/> 41214	<input checked="" type="checkbox"/> 41314	14 - 15 mm	10
		KT 15	<input type="checkbox"/> 41215	<input checked="" type="checkbox"/> 41315	15 - 16 mm	10
		KTs 16	<input type="checkbox"/> 39901	<input checked="" type="checkbox"/> 39912	16 mm	10
		KTs 17	<input type="checkbox"/> 39900	<input checked="" type="checkbox"/> 39913	17 mm	10
		KT oval		KT oval	<input type="checkbox"/> 39930	-
KT S1		KT S1	<input type="checkbox"/> 39931	-		10
KT tele		KT tele	<input type="checkbox"/> 39929	-	Telephone cable	10
KT tele1		KT tele1	<input type="checkbox"/> 41257	-	Data cable RJ12	10
KT tele2		KT tele2	<input type="checkbox"/> 41258	-	Data cable RJ10 / RJ45	10

*Only valid for gray product types

Accessories

ST Plugs 49

KT

Grommets, small, multi



Type	Order No gray	Order No black	Clamping range	PU	Description
------	------------------	-------------------	----------------	----	-------------

KT 2 2	<input type="checkbox"/> 39935	<input type="checkbox"/> 39936	2× Ø 2 mm	10	
KT 2 3	<input type="checkbox"/> 39939	<input type="checkbox"/> 39940	2× Ø 3 mm	10	
KT 2 4	<input type="checkbox"/> 39906	<input type="checkbox"/> 39907	2× Ø 4 mm	10	
KT 2 5	<input type="checkbox"/> 41200	<input type="checkbox"/> 39904	2× Ø 5 mm	10	
KT 2 6	<input type="checkbox"/> 41201	<input type="checkbox"/> 39905	2× Ø 6 mm	10	
KT 2 7	<input type="checkbox"/> 41202	<input type="checkbox"/> 39916	2× Ø 7 mm	10	
KT 2 8	<input type="checkbox"/> 39917	<input type="checkbox"/> 39918	2× Ø 8 mm	10	

KT 4 2	<input type="checkbox"/> 39937	<input type="checkbox"/> 39938	4× Ø 2 mm	10	
KT 4 3	<input type="checkbox"/> 39914	<input type="checkbox"/> 39915	4× Ø 3 mm	10	
KT 4 4	<input type="checkbox"/> 39909	<input type="checkbox"/> 39911	4× Ø 4 mm	10	
KT 4 5	<input type="checkbox"/> 39908	<input type="checkbox"/> 39910	4× Ø 5 mm	10	
KT 4 6	<input type="checkbox"/> 39932	<input type="checkbox"/> 39933	4× Ø 6 mm	10	

KT-ASI	<input type="checkbox"/> 39902	<input type="checkbox"/> 39903	1 ASI-cable	10	
KT-ASI2 r	<input type="checkbox"/> 39922	<input type="checkbox"/> 39924	2 ASI-cables	10	
KT-ASI2 l	<input type="checkbox"/> 39921	<input type="checkbox"/> 39923	2 ASI-cables	10	

KT ASI2 l	<input type="checkbox"/> 39921	<input type="checkbox"/> 39923	2 ASI-cables	10	
-----------	--------------------------------	--------------------------------	--------------	----	---

Product description

Cable grommets KT small are used with the following cable entry frames:

KEL-U/KEL-ER/KEL (8 - 34) | KVT (38 - 42)

The model range KT small is designed for cable diameters from 2 to 17 mm.

Assembly Note

When installing the grommets, the flat side should be facing the middle of the frame. This allows the flat sides of adjacent grommets to match up and provide a secure seal.

Specifications KT gray

Material	Elastomer
Flame class	UL94-Vo
IP rating	KT round, multi: IP54 KT special, multi: IP54
NEMA type rating	NEMA type 12 (acc. to UL 50E)
Temperature	- 40°C to + 90°C (static) - 40°F to + 194°F (static)
Properties	Halogen-free, silicone-free

Specifications KT black

Material	Elastomer
Flame class	UL94-HB
IP rating	KT round, multi: IP54 KT special, multi: IP54
NEMA type rating	NEMA type 12 (acc. to UL 50E)
Temperature	- 30°C to + 90°C (static) - 40°F to + 194°F (static)
Properties	Higher chemical resistance

*Only valid for gray product types

KT

Grommets, large



IP54 IP65

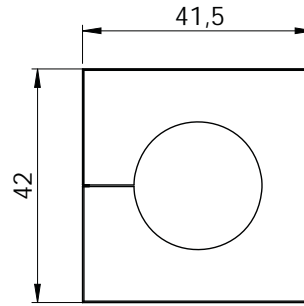

KT / KT-DPF large

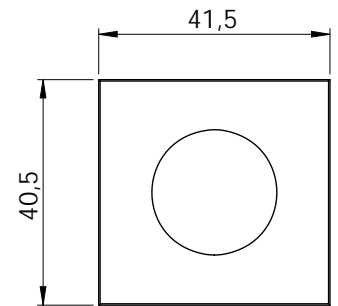

KTMB large

1

Product description

Cable grommets KT large accept a wide range of cable diameters from 16 to 35 mm. They are used with the following cable entry frames:

KEL-U/KEL-ER/KEL (8 - 34) | KVT (38 - 42)

ATG adapter grommets provide the possibility to hold a small KT grommet to reduce the clamping range down to 2 mm.

Specifications KT gray

Material: Elastomer
 Flame class: UL94-Vo
 IP rating: KT round, single: up to IP65 (in combination with KEL-ER frame) ATG/BTG: IP54
 NEMA type rating: up to NEMA type 4X (acc. to UL 50E)
 Temperature: -40°C to +90°C (static) / -40°F to +194°F (static)
 Properties: Halogen-free, silicone-free

Specifications KT black

Material: Elastomer
 Flame class: UL94-HB
 IP rating: KT round, single: up to IP65 (in combination with KEL-ER frame) ATG/BTG: IP54
 NEMA type rating: up to NEMA type 4X (acc. to UL 50E)
 Temperature: -30°C to +90°C (static) / -40°F to +194°F (static)
 Properties: Higher chemical resistance

Description	Type	Order No. gray	Order No. black	Clamping range	PU
-------------	------	----------------	-----------------	----------------	----

ATG		ATG	<input type="checkbox"/> 41253 <input checked="" type="checkbox"/> 41353	Adapter grommet	10
BTG		BTG	<input type="checkbox"/> 41252 <input checked="" type="checkbox"/> 41352	Blank grommet or 5 - 20 mm	10
KT round		KT 16	<input type="checkbox"/> 41216 <input checked="" type="checkbox"/> 41316	16 - 17 mm	10
		KT 17	<input type="checkbox"/> 41217 <input checked="" type="checkbox"/> 41317	17 - 18 mm	10
		KT 18	<input type="checkbox"/> 41218 <input checked="" type="checkbox"/> 41318	18 - 19 mm	10
		KT 19	<input type="checkbox"/> 41219 <input checked="" type="checkbox"/> 41319	19 - 20 mm	10
		KT 20	<input type="checkbox"/> 41220 <input checked="" type="checkbox"/> 41320	20 - 21 mm	10
		KT 21	<input type="checkbox"/> 41221 <input checked="" type="checkbox"/> 41321	21 - 22 mm	10
		KT 22	<input type="checkbox"/> 41222 <input checked="" type="checkbox"/> 41322	22 - 23 mm	10
		KT 23	<input type="checkbox"/> 41223 <input checked="" type="checkbox"/> 41323	23 - 24 mm	10
		KT 24	<input type="checkbox"/> 41224 <input checked="" type="checkbox"/> 41324	24 - 25 mm	10
		KT 25	<input type="checkbox"/> 41225 <input checked="" type="checkbox"/> 41325	25 - 26 mm	10
		KT 26	<input type="checkbox"/> 41226 <input checked="" type="checkbox"/> 41326	26 - 27 mm	10
		KT 27	<input type="checkbox"/> 41227 <input checked="" type="checkbox"/> 41327	27 - 28 mm	10
		KT 28	<input type="checkbox"/> 41228 <input checked="" type="checkbox"/> 41328	28 - 29 mm	10
		KT 29	<input type="checkbox"/> 41229 <input checked="" type="checkbox"/> 41329	29 - 30 mm	10
		KT 30	<input type="checkbox"/> 41230 <input checked="" type="checkbox"/> 41330	30 - 31 mm	10
		KT 31	<input type="checkbox"/> 41231 <input checked="" type="checkbox"/> 41331	31 - 32 mm	10
		KT 32	<input type="checkbox"/> 41232 <input checked="" type="checkbox"/> 41332	32 - 33 mm	10
		KT 33	<input type="checkbox"/> 41233 <input checked="" type="checkbox"/> 41333	33 - 34 mm	10
		KT 34	<input type="checkbox"/> 41234 <input checked="" type="checkbox"/> 41334	34 - 35 mm	10

*Only valid for gray product types

KT-DPF | KTMB

Grommets, Multi-Range

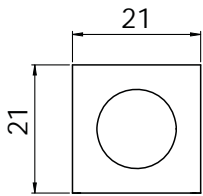





KT-DPF / KTMB small



KT-DPF-B

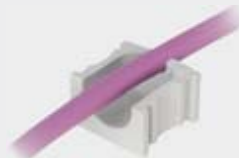

Type	Order No.	Size KT	Clamping range	PU	Description
------	-----------	------------	----------------	----	-------------

KT-DPF-A	<input type="checkbox"/> 41260 <input type="checkbox"/> 41360	KT small	3 - 12 mm	10	 <p>KT-DPF-A</p>
KT-DPF-B	<input type="checkbox"/> 41261 <input type="checkbox"/> 41361	KT large	4 - 18 mm	10	
KT-DPF-C	<input type="checkbox"/> 41262 <input type="checkbox"/> 41362	KT large	14 - 26 mm	10	 <p>KT-DPF-C</p>
KTMB-A	41432	KT small	2.5 - 6.5 mm	10	
KTMB-B	41434	KT small	4 - 7.5 mm	10	 <p>KTMB-D</p>
KTMB-C	41436	KT small	6.5 - 10 mm	10	
KTMB-D	41438	KT small	9.5 - 13 mm	10	
KTMB-E	41440	KT small	13 - 16 mm	10	 <p>Cross section KTMB</p>
KTMB-G	41460	KT large	13 - 18 mm	10	
KTMB-H	41465	KT large	18 - 23 mm	10	
KTMB-I	41470	KT large	23 - 28 mm	10	 <p>KTMB-I</p>
KTMB-J	41475	KT large	28 - 33 mm	10	
KTMB-K	41480	KT large	2x 13 - 18 mm	10	 <p>KTMB-K</p>

*Only valid for gray product types

Product description

The KT-DPF / KTMB grommets accept a wide range of cable diameters. A great benefit when the exact cable diameter is not known in advance. The KTMB grommets are not split and therefore only usable for cables without connectors. Cutting of KT-DPF grommets: Cable diameter less 20%.

Specifications gray

Material	Elastomer
Flame class	UL94-Vo
IP rating	IP54
NEMA type rating	NEMA type 12 (acc. to UL 50E)
Temperature	- 40°C to + 90°C (static) - 40°F to + 194°F (static)
Properties	Halogen-free, silicone-free

Specifications black

Material	Elastomer
Flame class	UL94-HB
IP rating	IP54
NEMA type rating	NEMA type 12 (acc. to UL 50E)
Temperature	- 30°C to + 90°C (static) - 40°F to + 194°F (static)
Properties	Higher chemical resistance

KMS Cable template

The correct size of the KT grommets can easily be determined by using the stainless steel cable template.

- Determining the diameter of the cable
- Selecting the KT grommets according
- to the data on the cable template

Order No. 39800



DT

Membrane Cable Grommets



1

Description	Type	Order No.	Number of cables	PU
-------------	------	-----------	------------------	----

Product Description

The DT cable grommets are designed for cables without preassembled connectors. A large number of cables can be routed utilizing minimal space.

DT grommets are designed to fit in KT large grommet spaces of the following products:

KEL-U/KEL-ER/KEL (8 - 34) | KVT (38 - 42)

The DT grommets are also perfectly suitable for the assembly of subsequently terminated cable harnesses.

Advantages & Benefits

- Combination of routing pre-terminated cables and cables without connectors with one cable entry frame
- Enables subassembly of cable harnesses
- High cable density

Specifications

Material	Elastomer
Flame class	UL94-Vo
IP rating	IP54
NEMA type rating	NEMA type 12 (acc. to UL 50E)
Temperature	- 40°C to + 90°C (static) - 40°F to + 194°F (static)
Properties	Halogen-free, silicone-free

Accessories

ST-B Plugs 76

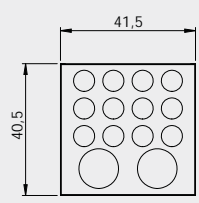
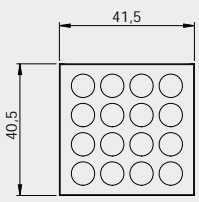
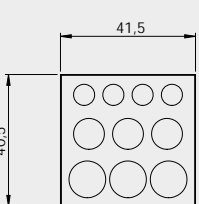
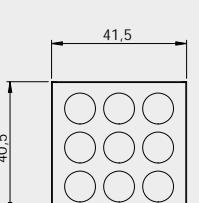
	DT 1	41500	12× max. 6.5 mm 2× max. 12.2 mm	10
	DT 2	41510	16× max. 7.1 mm	10
	DT 3	41520	4× max. 6.5 mm 3× max. 9.5 mm 3× max. 11.3 mm	10
	DT 4	41530	9× max. 9.5 mm	10

KEL-EMC-Z

Grounding Mount with Strain Relief

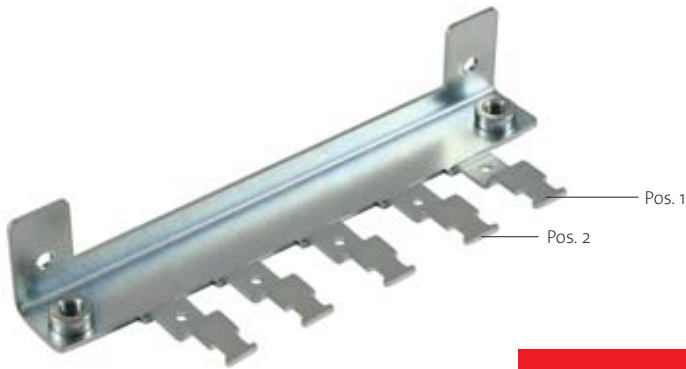

Type	Order No.	No. of teeth	Fastening	Fits with	PU
------	-----------	--------------	-----------	-----------	----

KEL-EMC-Z 16 4	36525	4	long side	KEL-E4 KEL 16 x KEL-U 16 x KEL-ER 16 x KEL-QUICK 16	1
KEL-EMC-Z 24 5	36527	5	long side	KEL-E5 KEL 24 x KEL-U 24 x KEL-ER 24 x KEL-QUICK 24	1

Product Description

Cable entry, EMC shielding and strain relief – all in one location!

Cables pass through the KEL cable entry and insert directly to the EMC clamps and strain relief.

Simply insert the cable shield into the shield clamp and secure the cable jacket to the strain relief. Two separate functions acc. to regulations – carried out quickly and easily!

Custom configurations are available for shield clamps up to 16 mm in diameter with minimal order quantities and lead time.

Advantages & Benefits

- Large surface contact between cable shield and housing, especially on conductive coated surfaces
- Sealing by outer cable jacket – EMC shielding by cable shield (in acc. with regulations)
- Combined routing and fastening with the KEL cable entry system
- Available without SKL shield clamps if only additional strain relief is required
- Mounting hole for ground strap or PE connection

Specifications

Material **Carbon steel, zinc plated**

Compatible with

KEL-U Cable entry frames	8 - 14
KEL-ER Cable entry frames	9 - 17
KEL Cable entry frames	16 - 27
KEL-QUICK Cable entry frames	50 - 51

KEL-EMC-Z 16|4

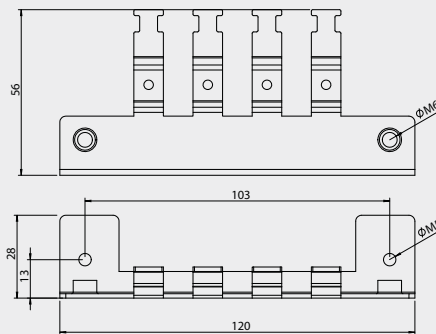

KEL-EMC-Z 24|5

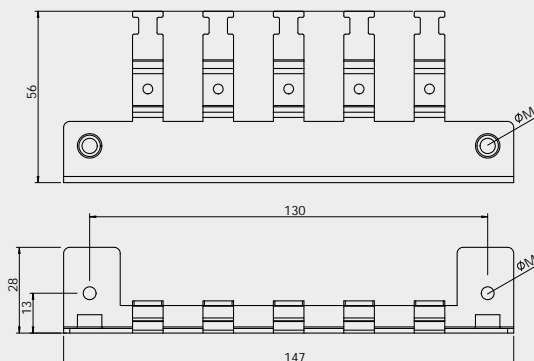

KEL-EMC-PF

Grounding Mount, Bracket Version

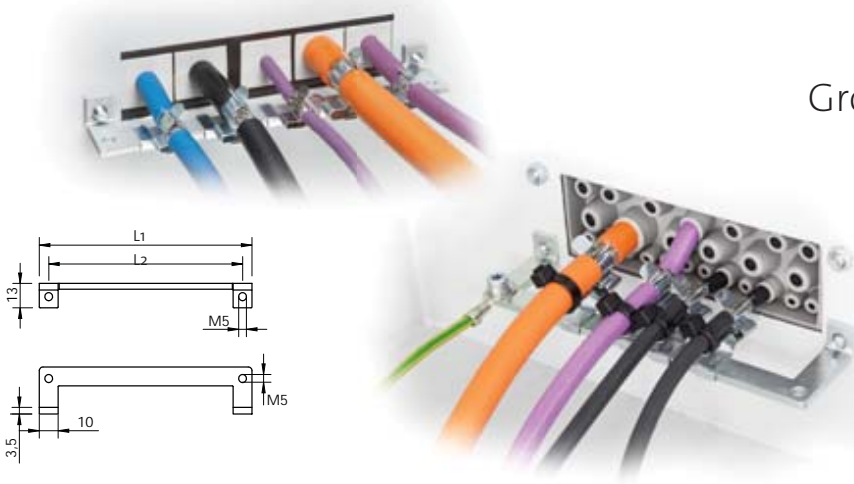

Type	Fits with	Order No.	Length L1	Length L2	PU
KEL-EMC-PF B4	KEL-E2 KEL-B KEL-U-B KEL-ER-B	39150	68 mm	58 mm	1
KEL-EMC-PF 10	KEL-E3 KEL 10 x KEL-U 10 x KEL-ER 10 x	39160	93 mm	83 mm	1
KEL-EMC-PF 16	KEL-E4 KEL 16 x KEL-U 16 x KEL-ER 16 x	39170	113 mm	103 mm	1
KEL-EMC-PF 24	KEL-E5 KEL 24 x KEL-U 24 x KEL-ER 24 x KEL-DPZ 24 x KEL-DPZ-E	39180	140 mm	130 mm	1

Product Description

The EMC bracket combined with the matching PFS|SKL EMC shield clamp is perfect in conjunction with the KEL cable entry frame for alleviating interferences due to shields.

The EMC clamp is assembled inside the control panel. For this process the same fixing screws for the assembly of the KEL frame on the control panel are used. A female screw thread M5 is already integrated in the KEL-EMC-PF bracket.

Depending on the cable diameter, the corresponding PFS|SKL EMC shield clamp can be snapped onto the EMC bracket.

Advantages & Benefits

- Supports a wide range of cable and wire sizes
- Large surface contact of the cable shield
- Permanent spring pressure on the cable shield
- Fast and easy assembly

Specifications

Material Carbon steel, galvanically zinc plated

Compatible with

KEL-U Cable entry frames	8 - 14
KEL-ER Cable entry frames	9 - 17
KEL Cable entry frames	16 - 27
KEL-QUICK Cable entry frames	50 - 51
KEL-BES Brush frames	57
KEL-DPU Cable entry plates	62 - 63
KEL-DPZ Cable entry plates	64 - 67
PFSZ SKL Shield clamps	100
PFS SKL Shield clamps	101

KEL-EMC

Grounding Mount



Product Description

Installation of pre-terminated cables without shield interruption.

Advantages & Benefits

- Direct, easy and quick contact to the enclosure
- Space saving, usable for up to 10 cables with the two row model
- Replacement for EMC cable glands, even for pre-terminated cables
- Low resistance shield contact

Specifications

Material **Stainless steel**

Compatible with

KEL-U Cable entry frames	8 - 14
KEL-ER Cable entry frames	9 - 17
KEL Cable entry frames	16 - 27
KEL-QUICK Cable entry frames	50 - 51

Type	Order No.	No. of teeth	Fastening	Fits with	PU
KEL-EMC-B	36520	2	long side	KEL-E2 KEL(-U)-B x KEL-ER-B x KEL-QUICK-B2 B4	5
KEL-EMC 10	36522	3	long side	KEL-E3 KEL(-U) 10 x KEL-ER 10 x	5
KEL-EMC 16 4	36524	4	long side	KEL-E4 KEL(-U) 16 x KEL-ER 16 x KEL-QUICK 16	5
KEL-EMC 24 5	36526	5	long side	KEL-E5 KEL(-U) 24 x KEL-ER 24 x KEL-QUICK 24	5
KEL-EMC F	39110	3	narrow side	KEL(-U)-B x KEL-ER-B x KEL(-U) 10 x KEL-ER 10 x KEL(-U) 16 x KEL-ER 16 x KEL(-U) 24 x KEL-ER 24 x	5